

A Novel Method of Testing for Susceptibility of Audio Equipment to Interference from Medium and High Frequency Radio Transmitters

Jim Brown
Audio Systems Group, Inc.
Chicago, IL, 60640 USA
jim@audiosystemsgroup.com

This paper was presented at the 115th AES Convention in New York, October 2003. You can search the complete AES Electronic Library at <http://www.aes.org/e-lib/> This paper is available as Preprint 5898.

ABSTRACT

It has been shown [1, 2] that radio frequency (RF) current flowing on the shield of balanced audio wiring will be converted to a differential signal on the balanced pair by a cable-related mechanism commonly known as Shield-Current-Induced Noise. This paper investigates the susceptibility of audio input and output circuits to differential signals in the 200 kHz - 30 MHz range, with some work extending to 300 MHz. Simple laboratory test methods are described, equipment is tested, and results are presented. Laboratory data are correlated with EMI observed in the field.

INTRODUCTION

Brown and Josephson [3] recently studied the susceptibility of capacitor microphones to VHF and UHF fields. A wide variety of contemporary and vintage microphones was tested, and the results were summarized. They concluded that interfering signals entered the microphones by two principal mechanisms. Those mechanisms were 1) common impedance coupling caused by improper termination of the cable shield within the microphone, a fault that Muncy [1] named "the pin 1 problem;" and 2) inadequate differential mode bandpass filtering and/or decoupling of the balanced signal pair. Research on measurement of the pin 1 problem is reported on in another paper. [4]

RF interference is coupled to the signal pair by at least three mechanisms. They are:

- ♦ Imbalance in the magnetic coupling between the shield and the two signal conductors (Shield-current-induced noise) [1, 2]
- ♦ Voltage gradients resulting from imbalance in the capacitances between the two signal

conductors and the shield [6]

- ♦ Coupling of the electric field through tiny openings in the shield [7]

All of these mechanisms increase in magnitude with increasing frequency. All, however, can have strongly reactive components that are of opposing sign. As a result, the total signal coupled into a given circuit, or to various points along an audio cable that at RF is essentially a transmission line or an antenna, will vary in a complex way with frequency as reactive components either cancel or reinforce each other, and as their magnitude and phase relative to each other vary with frequency. [2]

Whitlock presents [2] a convincing first order, low frequency analysis of a length of balanced audio cable as a three winding transformer, where the shield is a primary, and each of the signal conductors is a secondary. In perfectly manufactured cable, the turns ratio would be precisely 1:1:1. Practical cables are manufactured with only modest precision, so the

turns ratio and other balances will deviate from unity. In addition, various forms of cable construction, especially the use of a drain wire having the same lay as the signal conductors and wound more closely to one signal conductor than the other, will induce unequal voltages onto the two signal conductors when current flows on the shield. The resulting differential voltage is linearly related to shield current (although not necessarily linear with respect to frequency).

A test circuit was developed to use this property of the cable as a means of injecting RF interference onto the signal pair for the purpose of evaluating the susceptibility of a Device Under Test (DUT) to a differential RF signal at its input. A variation of the circuit could (and should) be used to test the susceptibility of output circuits, which, in the author's experience, often have serious susceptibility issues. The test circuit is shown in Figure 1.

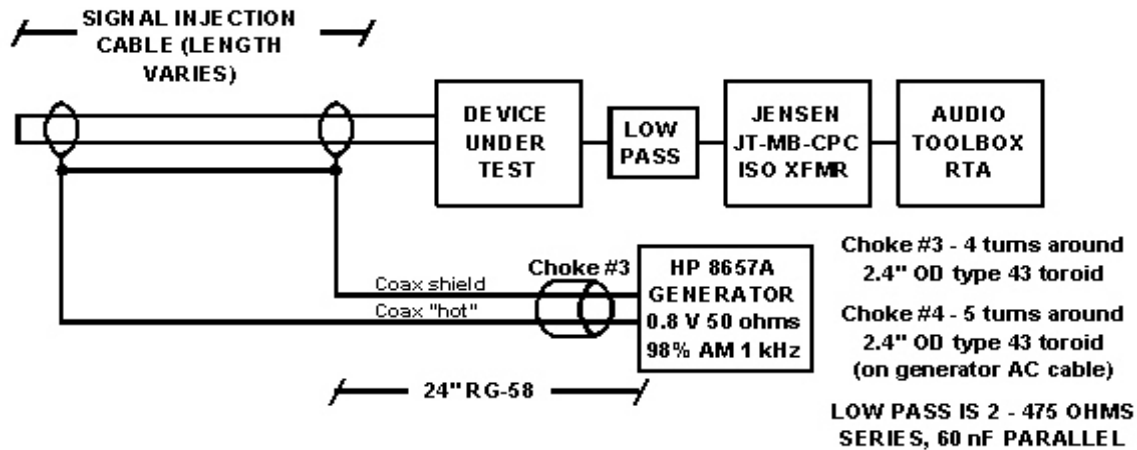

Figure 1 The signal injection circuit for equipment.

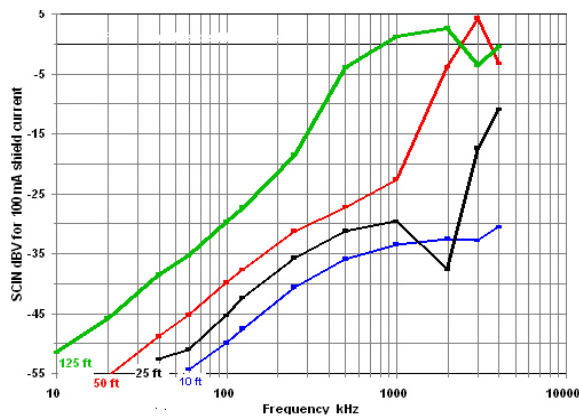

Figure 2 Measured Shield-Current Induced Noise for various lengths of a typical foil/drain shielded cable for a shield current of 100 ma [2]

If the shield current were held constant, SCIN would be proportional to frequency and cable length, absent transmission line effects. The RF generator is essentially a constant voltage source with a 50 ohm source impedance. Figure 2 shows performance of a typical foil/drain shielded cable similar to the type used here.

The impedance of the injection cable's shield also varies with frequency. The current will be approximately equal to the generator's open circuit voltage divided by the series impedance of the generator and the cable shield. At low frequencies, and at higher frequencies for short cables, this impedance is primarily composed of the generator impedance. As frequency increases, and with longer cables, the cable inductance becomes increasingly important and even-

tually dominates. At frequencies below about 500 kHz the source impedance of the generator used in these tests rises and its source voltage drops. Figure 3 show these relationships.

The effects of the generator, the complex impedance of the shield, and SCIN combine to form a useful, although not very precise, method for the injection of broadband RF interference. Over the frequency range where the current is determined by the generator impedance and essentially constant, the injected signal rises approximately linearly with frequency. But at higher frequencies where the current is largely determined by the cable inductance the injected signal is essentially uniform, not only with frequency, but also with cable length! This can be seen from an analysis of Figure 8, where the data for 50 ft, 25 ft, and 10 ft cable lengths essentially overlay each other. It is also evident in data for many of the microphones, especially at higher frequencies. In summary, due to the relationship between the generator impedance and the load impedance (the cable shield), the generator acts as a constant current source at low frequencies, gradually transitioning to acting as a constant voltage source at higher frequencies.

A Hewlett Packard model 8657A was used as a signal source. This synthesized generator is rated for +13 dBm into 50 ohms between 1 MHz and 1 GHz, and can be amplitude or frequency modulated by its own internal generator at 400 Hz or 1 kHz, or by an external generator. When driving the shield of the 38m (125 ft) cable, which is predominantly inductive

at these frequencies, the generator is capable of an unmodulated output of about 18 mA at 500 kHz and 9mA at 1 MHz. With 100% amplitude modulation, the average RF output is 6 dB lower. The author has found that these currents are representative of those likely to be induced in exposed audio lines (that is, lines not enclosed by grounded metallic conduit) of comparable length at a distance of 1 mile from an omnidirectional 50 kW AM broadcast transmitting antenna. [2]

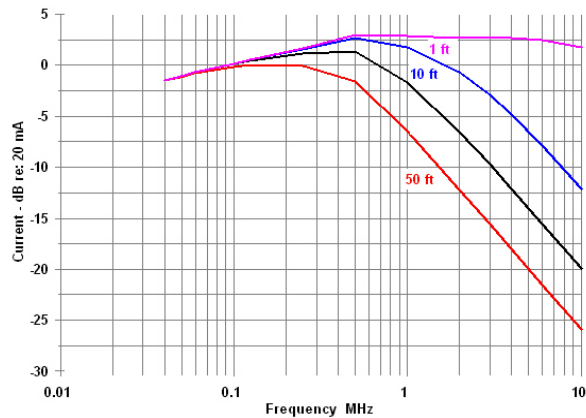

Figure 3 Computed shield current vs. cable length, ignoring resonances and transmission line effects. Computations are based on generator voltage and impedance measurements and cable inductance data.

Superimposed on the smooth curves of Figures 3 are the complex variations in current, voltage, and impedance that result from resonances and transmission line effects in the combination of the DUT, the microphone cable, and even the cable between the generator and the injection cable. These variations are responsible for the departures from approximately linear behavior in Figure 2 and are present throughout the measurements presented herein.

It should be noted that additional departures from smooth response will be contributed by the response of the path (or paths) taken by the RF within the DUT to the point (or points) where detection occurs. Variations will also result from algebraic addition of signal detected at multiple points, by algebraic addition of the RF signal paths to the detection points, and even by the combination of detection due to RF coupled by pin 1 susceptibility with detection coupled by signal pair susceptibility.

The Real Time Analyzer function of an Audio Toolbox was used as an audio voltmeter preceded by the built-in one-third octave bandpass filter corresponding to the 1 kHz modulation frequency of the RF generator. This permits accurate measurement of the demodulated interference at levels that are barely audible and very close to the noise floor.

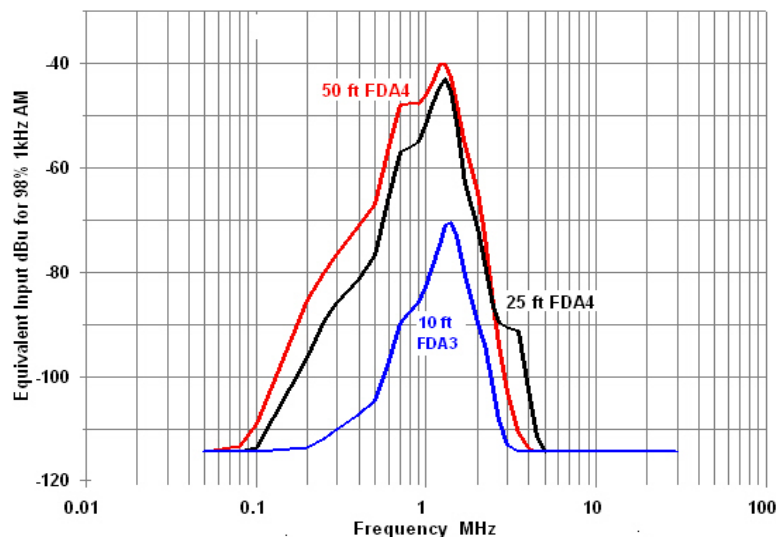

Figure 4 - Susceptibility of the Audio Toolbox to differential signal induced by shield current from the 800 mv 50 ohm RF generator, amplitude modulated to 98% at 1 kHz. The isolation transformer and low pass filter are not in line for this measurement.

The generator, set for 800 mV and 98% amplitude modulation by a 1 kHz sine wave, had its carrier frequency varied over the range of 200 kHz to 30 MHz in steps sufficiently small to note variations in susceptibility with frequency. At each frequency, the level of the 1 kHz one-third octave band was noted. Initially it was planned to use 125 ft, 50 ft, 25 ft, and 10 ft lengths of injection cable, corresponding to the

cable samples tested for [2]. Cable lengths of 125 ft were not used for the laboratory tests. Part way through the research reported here, it was decided to extend the range of measurements to 100 MHz for 50 ft and 25 ft cable lengths, and to 300 MHz for 10 ft and 1 ft cable lengths. Most of the microphones were measured for this extended range, but only one of the mixers was.

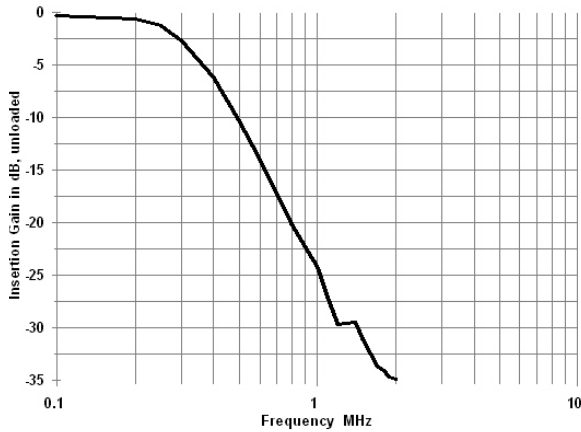

Figure 5 - Low Pass Response of Jensen JE-MB-CPC

The first unit tested was the Audio Toolbox. Several of the devices tested passed input signals in the 100 kHz to 500 kHz range with significant gain. Figure 4 shows that the Audio Toolbox could demodulate these signals and introduce errors, thus some significant bandpass filtering must be applied to the measurement system.

Some of the susceptibility in the Audio Toolbox is to

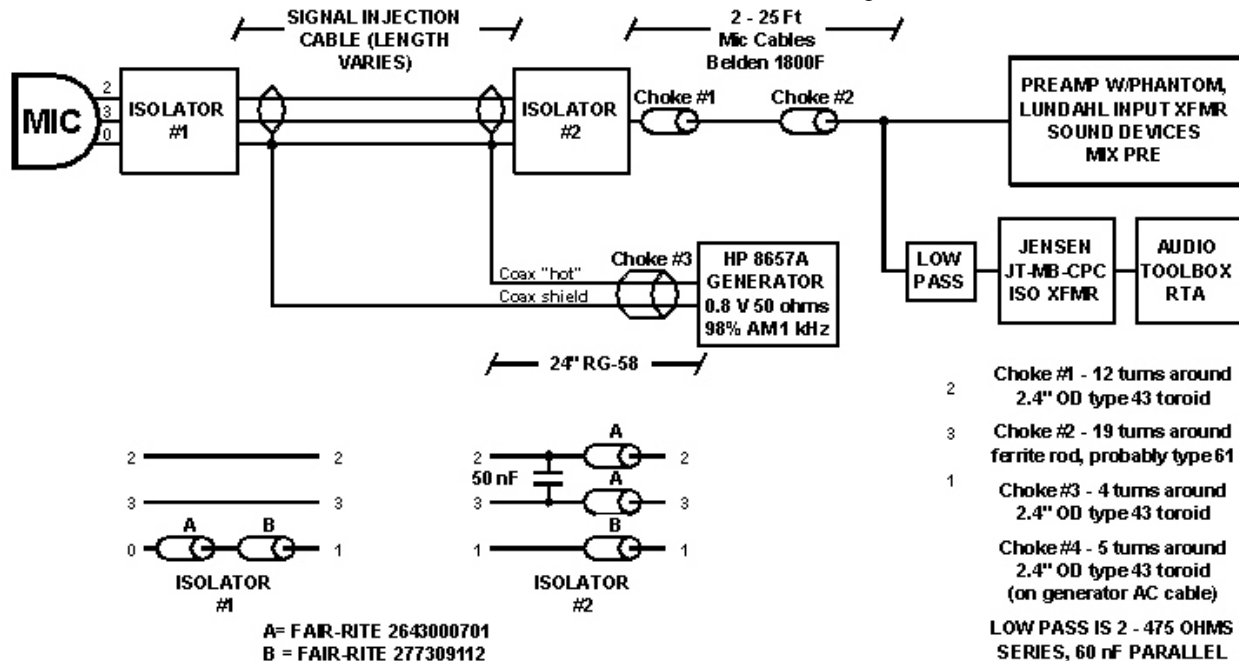

Figure 6 The microphone test setup

The isolators have several purposes. First, they confine RF current flow to the shield of the injection cable. Second, they couple the differentially injected signal to the microphone. Third, they should minimize the leakage of differential mode RF to the detector. Fourth, they should isolate the injection cable from the complex impedance of the cable leading to the detector. Fifth, they allow audio, including any detected 1 kHz, to reach the preamp. The chokes on the mic cable leading to the detector provide addi-

common mode signal at its input. In addition to providing common mode isolation, Figure 5 shows that the Jensen isolation transformer also functions approximately as a three-pole, 300 kHz low pass filter to differential mode signals. When additional filtering was needed, a single pole low pass filter with a turn-over frequency of about 3 kHz was added in line with the Audio Toolbox input.

MICROPHONE TEST SETUP

Figure 6 shows the more complex arrangement used to test the susceptibility of capacitor microphones.

Cable adapters were constructed so that the RF signal generator could drive current through the shield of various lengths of balanced audio cable connecting the microphone with a microphone preamplifier. A small pigtail on each adapter allowed connection of the generator to the shield at each end of the injection cable, and the cable was laid out in a large loop around the author's laboratory so that both ends of the cable were at the generator. The Sound Devices pre-amplifier includes Lundahl input transformers, as well as a built-in headphone amplifier that was used to monitor the output.

tional inductance to further limit common mode current below 1 MHz. The chokes on the generator's output and power cables are intended to minimize stray current flow at HF and VHF. The behavior and uses of ferrite beads is discussed in [4].

Once susceptibility was eliminated from the test setup, the Sound Devices Mix Pre was tested. The lab data are shown in Figure 8. This unit was free of interference in all field testing with the exception of

some audible squealing at high audio frequencies in the presence of the HF transmitters at 3.5 and 7 MHz.

The squealing was also visible on the RTA connected to its output for the lab tests.

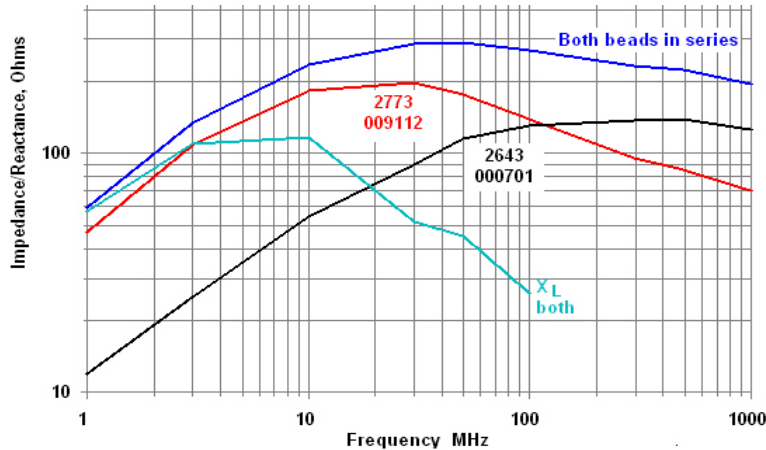

Figure 7 Impedance of the ferrite beads used in the isolators

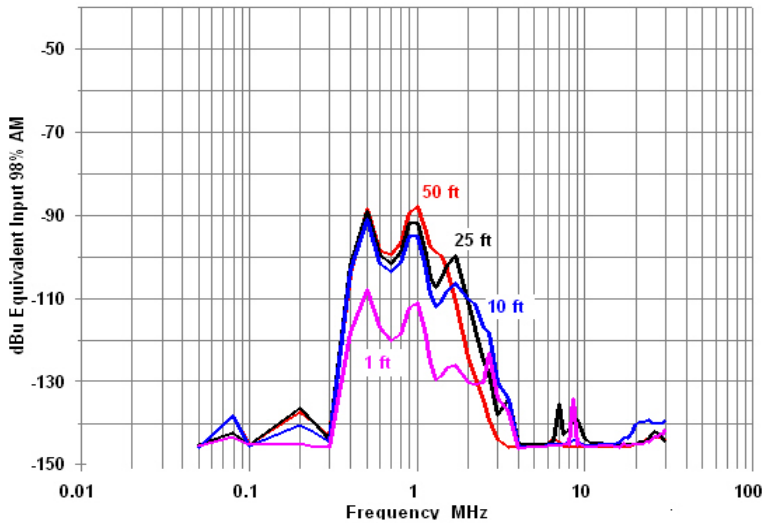

Figure 8 - Susceptibility of the Sound Devices MixPre used in the microphone tests

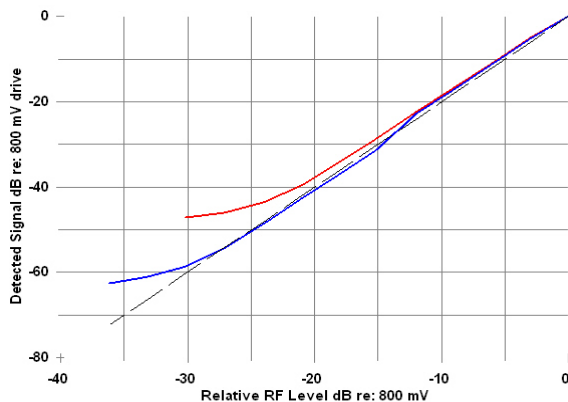

Figure 9 - Detected 1 kHz vs. level of the modulated RF signal for two typical microphones. The dashed line is square law response.

Because most RF susceptibility is the result of some form of square law detection, the detected signal increases as the square of the interfering signal. Thus a 10 dB increase in RF signal strength results in a 20

dB increase in the detected signal. Figure 9 illustrates this relationship for two typical microphones. The curvature at the lower extent of each curve occurs at the acoustic noise floor of the author's laboratory.

FIELD TESTING

In addition to the laboratory testing, microphones and other equipment were exposed to strong radio frequency fields from nearby transmitters, so that laboratory data could be correlated with practical conditions of use. Two tests were arranged. First, all of the microphones and other equipment were set up in an open field about 600 m from a 50 kW broadcast station transmitting on 720 kHz with single vertical antenna of 195 electrical degrees height. A second 50 kW transmitter on 780 kHz was at 2 km distance with a comparable antenna. These transmitters are the most powerful used in the United States for standard AM broadcasting (540-1700 kHz). The microphones were set up on stands and connected alternately by 40

m lengths of foil/drain shielded cable and braid/drain shielded cable to the Sound Devices preamp. The cables were suspended approximately 1.5 m above the ground by portable loudspeaker stands. Prior to testing the microphones, the Sound Devices preamp was tested with a dynamic microphone and found to be free of interference. The Audio Toolbox was tested in the same setup and found to be free of interference with the braid-shielded cable. but it received significant interference with the foil/drain cable.

In the second series of field tests, the selection of microphones and equipment was set up at an amateur radio "Field Day" site. For this annual 24-hour long event, groups of "ham" radio operators throughout North America set up multiple transmitters, temporary antennas, and emergency power generators in places like public parks, mountain tops, and farms as a test of their preparedness for emergencies.

At the site visited for this round of testing, transmitters were in use at 1.8 MHz, 3.5 MHz, 7 MHz, 14 MHz, and 28 MHz. All operated at radiated power levels on the order of 100 watts using dipole antennas about 8 m above the ground. Microphones were set up on 2-m stands directly under the antennas, and the 24-m long mic cables were run directly under the antennas and approximately parallel to them to the battery powered preamplifier. The mic cables were held about 1.5 m off the ground by portable loudspeaker stands. The presence or absence of interference was observed on headphones connected to the mixers or other DUT. The mics and other equipment were tested separately with both foil/drain and braid/drain shielded cables.

Several conditions were common to all field tests. The cables were wired per AES14 -- that is, the shield was connected only to pin 1. The shielding enclosure of the input equipment was bonded to local ground. For the 720 kHz tests, this was a rod driven about 1 m into relatively moist earth (there had been recent rain). For the "Field Day" tests, it was the system ground established for the transmitters. Providing a ground establishes shield current that would be roughly comparable to the installation of exposed (that is, not in metallic conduit) wiring in a typical church. While the resistive impedance to earth may be higher than in a well grounded building, the inductive component in these tests is much less because the ground cable is only about 2 m in length. Microphones were grounded only via the cable connecting them to the preamp. When the DUT was input equipment (mixers and the DAT machine), it was fed by a dynamic microphone. For all tests, only a single microphone and cable were connected to the input equipment at one time.

MICROPHONE TEST RESULTS

A wide variety of microphones was tested, including many of those tested by other means in the lab and in the field for VHF/UHF susceptibility. [1] Designations established for that paper to describe and identify the microphones are used here. Two new microphones were added to the group of test subjects. DS3-2-25 is a small diaphragm cardioid similar in electrical design to DL3-1-10. DS1-2-10 is quite similar to DS1, but optimized for vocal use by reduced input sensitivity and the addition of a windscreen. DS1-2-10 was available for the VHF/UHF tests but not tested because it was believed then to be identical to DS1. It was subsequently learned that DS1 has a plastic XL shell that makes no contact with the mating connector shell, requiring a unique adapter to include it in this research. Rather than construct another adapter, it was decided to add the vocal mic to the test. Some of the microphones tested for [1] were not available for inclusion in the current work. Others were omitted simply because there wasn't time to include them.

Results from this more recent work correlate quite well with the earlier VHF/UHF tests, and the new test method provides an important and more closely controlled option for the equipment designer. Microphone test results fell into several distinct groups. A few mics received almost no interference in any of the field tests, both with foil/drain and braid shielded cables. The next group received moderate to strong interference at some frequencies, but little or none at others. The third group received moderate to strong interference at most of the transmitter frequencies.

With some microphones, no tone was detected at some test frequencies, but switching transients were heard as the RF carrier was switched on and off. With mics having the best performance, neither detected 1 kHz modulation nor switching transients were heard over much of the spectrum.

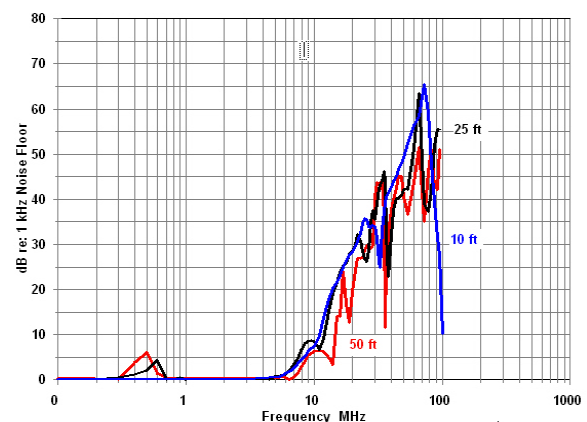

Figure 10 Susceptibility to SCIN coupled voltage on the signal pair for microphone TMO5

Microphone TMO5 was free of interference below 10 MHz, but received moderately strong interference at 14 MHz and 28 MHz. Microphone TS3-1-10 received mild interference below 10 MHz, but strong interference at 14 MHz and 28 MHz. In both cases, this is consistent with the lab data, as shown in Figure 10 and 11.

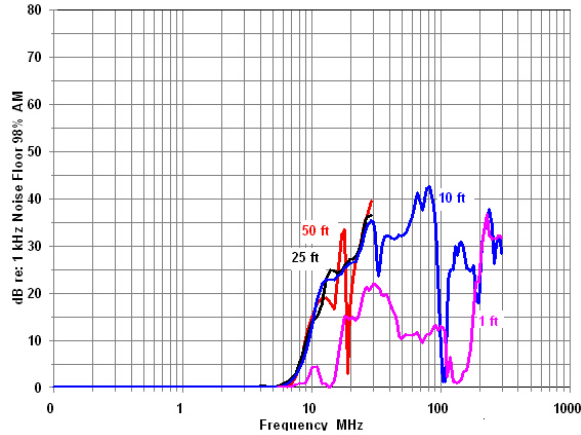

Figure 11 Susceptibility to SCIN coupled voltage on the signal pair for microphone TS3-1-10

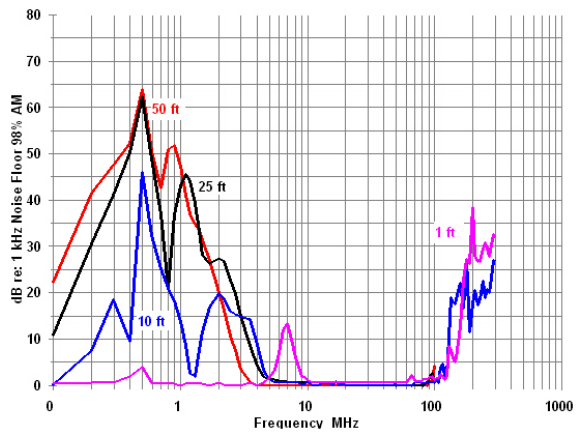

Figure 12 Susceptibility to SCIN coupled voltage on the signal pair for mic DS4.

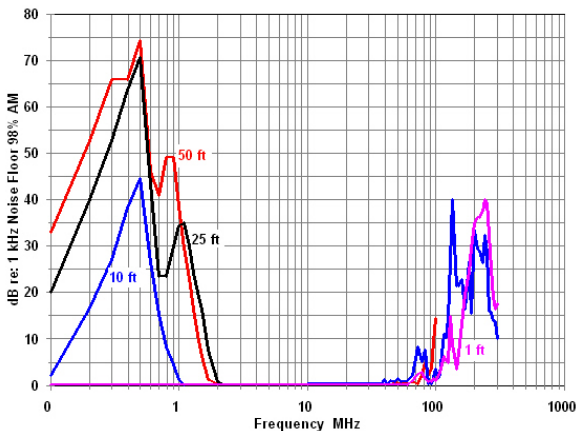

Figure 13 Susceptibility to SCIN coupled voltage on the signal pair for mic DL4-2-10.

The two microphones from manufacturer #4 fell into the second group. Both received interference only with foil/drain cable. Microphone DL4-2-10 received moderate interference only from the 720 kHz broadcast transmitter, while DS4 received moderately strong interference at 720 kHz, strong interference at 1.8 MHz, and mild interference at 3.5 MHz, but none at 7, 14, or 28 MHz. An analysis of Figure 12 and 13 explains why -- their susceptibility in the lab tests correlates almost perfectly with the field data.

Two relatively new microphones from manufacturer #3 measured and performed similarly. The newest model, DS3-2-25, received moderate interference from the 720 kHz and 1.8 MHz transmitters, strong interference at 3.5 MHz, mild interference at 7 MHz, very strong interference at 14 MHz, and none at 28 MHz. Microphone DL3-1-15 received moderate interference at 720 kHz and 1.8 MHz, strong interference at 3.5 MHz, none at 7 MHz, extremely strong interference at 14 MHz, and none at 28 MHz. The field results correlated quite well with the data, shown in Figure 14 and Figure 15.

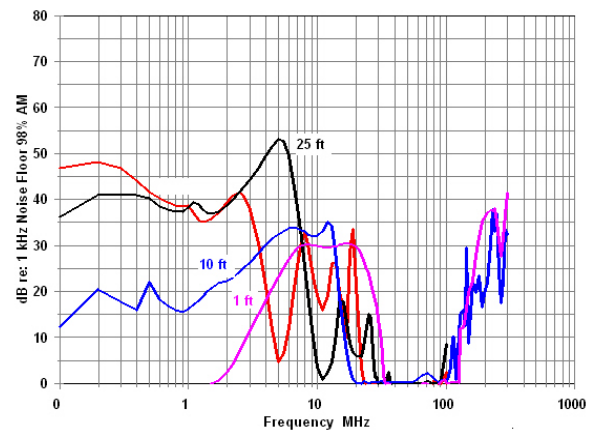

Figure 14 Susceptibility to SCIN coupled voltage on the signal pair for mic DS3-2-25.

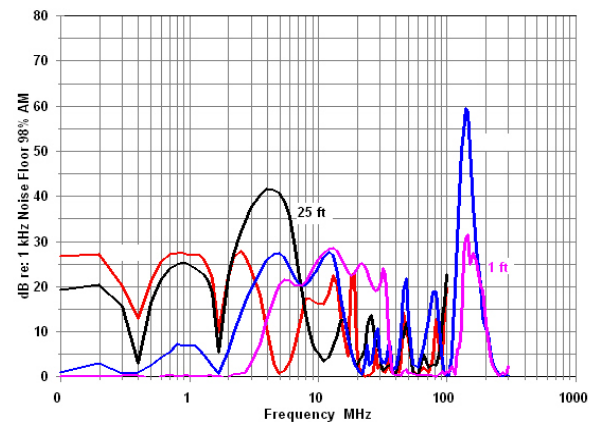

Figure 15 - Susceptibility to SCIN coupled voltage on the signal pair for mic DL3-1-15.

Microphones TS3-2-25 and TL3-1-15 appear to depend upon common mode filtering to eliminate RF

interference from the signal pair, with little or no differential mode filtering. The results of these tests, as well as those of the earlier VHF/UHF tests, suggest that lack of differential mode filtering is a cause of immunity failures in these microphones.

Two recent microphones from manufacturer #2 performed quite differently. TL2-20 received no interference in any of the field tests. Figure 17 is consistent with this result, although it suggests that longer mic lines could have put it over its threshold for detection. On the other hand, DS2-10 received strong to very strong interference at 1.8 MHz, 3.5 MHz, 14 MHz, and 28 MHz. Figure 16 is consistent with interference at 14 MHz and 28 MHz, but it does not explain the strong interference at 1.8 MHz and 3.5 MHz.

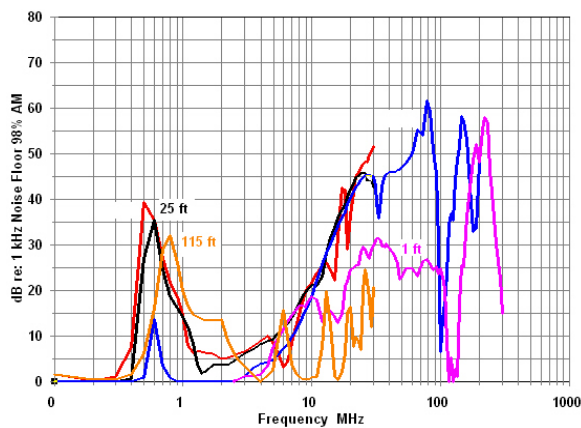

Figure 16 Susceptibility to SCIN coupled voltage on the signal pair for mic DS2-10.

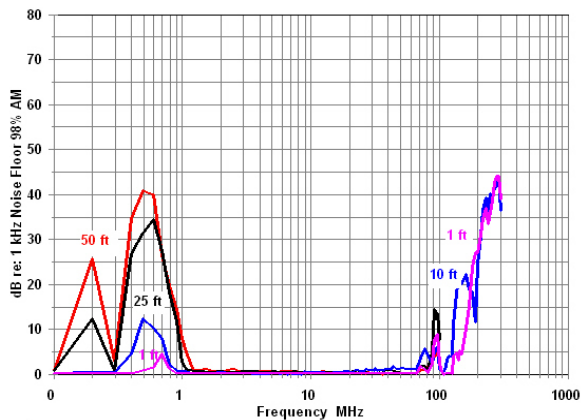

Figure 17 Susceptibility to SCIN coupled voltage on the signal pair for mic TL2-20.

Figure 18 suggests that microphone TL1-1-10 has very good immunity to RF on the signal pair below about 15 MHz, but significant susceptibility that rises rapidly at about 20 MHz to become severe by 70 MHz. In field tests, the microphone received only very mild interference from the 1.8 MHz and 3.5 MHz transmitters, and only with the foil/drain shielded cable. The microphone also exhibited high

susceptibility to pin 1 current above 50 MHz, and was by far the poorest performer in the VHF/UHF immunity tests reported in [3].

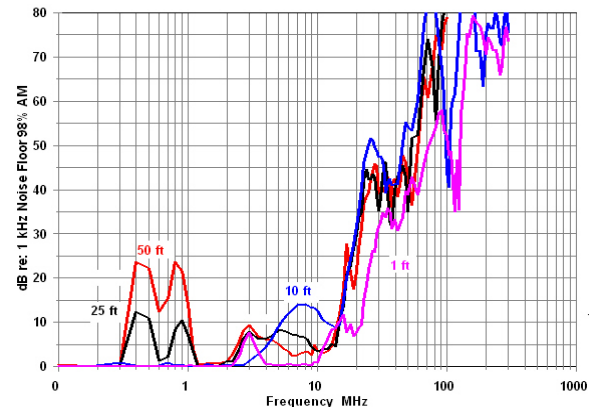

Figure 18 Susceptibility to SCIN coupled voltage on the signal pair for microphone TL1-1-10.

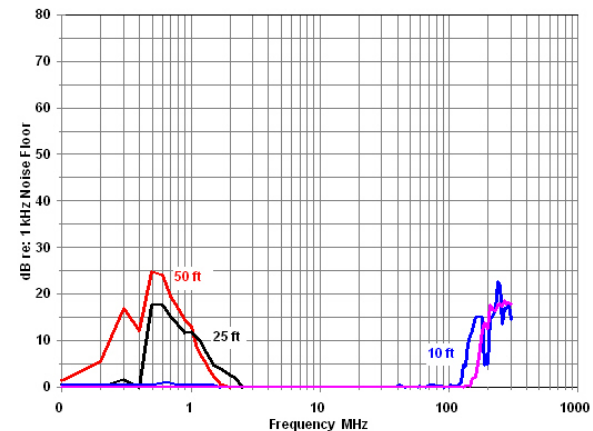

Figure 19 Susceptibility to SCIN-coupled voltage on the signal pair for microphone DS1-2-10

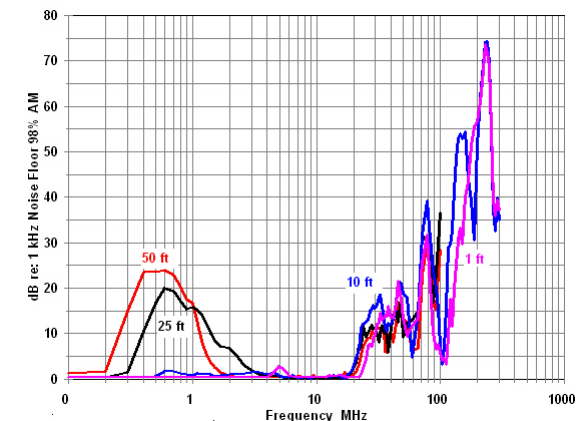

Figure 20 Susceptibility to SCIN coupled voltage on the signal pair for mic DL1-2-10.

Figure 19 and 20 show data for two microphones that received interference at 1.8 MHz and 3.5 MHz. Parallel work [4] suggests that the interference in mic DS1-2-10 is probably due to a pin 1 problem. Interference received by DL1-2-10 at 1.8 MHz and 3.5

MHz is not explained by either study. Neither mic received interference at 720 kHz, 7 MHz, 14 MHz, or 28 MHz.

A study of the layout of the output wiring for DL1-2-10 is informative. In [1] and [3] the author showed how susceptibility of DL1-2-10 could be improved by reducing a pin 1 problem. The black wire in Figure 21 was moved by the author from pin 1 to the chassis screw, improving susceptibility by 20 dB above about 450 MHz.

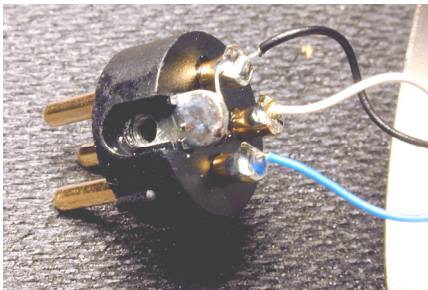

Figure 21 - Pin 1 termination in microphone DL1-2-10 as manufactured. The black wire goes to circuit common.

But that isn't the only coupling mechanism that can be inferred from the photo. The white and blue leads are the signal pair, and they carry whatever RF may be present on the signal pair. They will lay next to the circuit board when the mic is reassembled, and in this position, will couple RF from the signal pair both inductively and capacitively to the circuit board. In the research reported in [3], this microphone received significant interference from VHF and UHF television stations, handheld transmitters, and cell phones, and Figure 20 shows susceptibility to RF on the signal pair becoming significant above about 80 MHz.

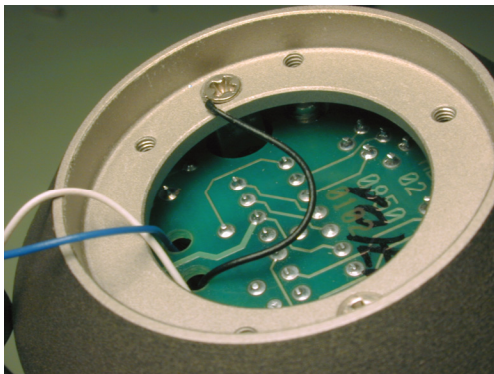

Figure 22 - New location for the black wire that was connected to pin 1 in microphone DL1-2-10

To reduce this coupling, one of the author's mics was modified by the addition of type A ferrite beads on the blue and white wire very close to the connector. The level of interference from the handheld UHF transmitter and cell phone using the test methods of [3] is significantly less with the modified micro-

phone. Although it was not practical for the author to do so, addition of small value bypass capacitors between the signal pair and the microphone shell would further reduce susceptibility. The ideal solution, of course, is use the beads and bypass capacitor but also redesign the microphone to keep the wiring out of proximity with the circuit board.

EQUIPMENT TEST RESULTS

In addition to the Sound Devices and Audio Toolbox units used in the test setup, four low cost mixers from the same manufacturer were tested. Time constraints prevented the measurement of additional products, but it is the author's hope that the current effort is sufficient to demonstrate the method, the pitfalls, and the design issues.

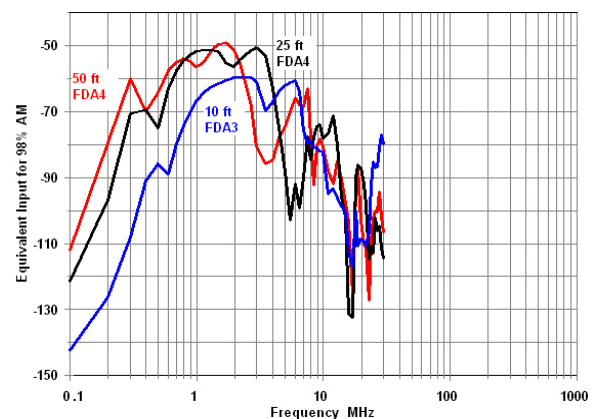

Figure 23 Susceptibility to SCIN coupled voltage on the signal pair for a 4-input mixer.

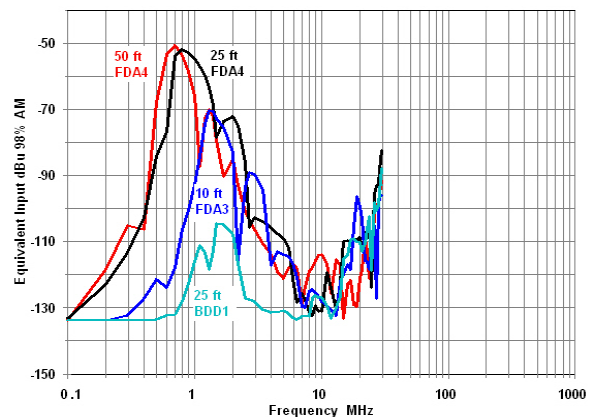

Figure 24 Susceptibility to SCIN coupled voltage on the signal pair for a 16-input mixer.

The mixers were manufactured over a period of about five years during which the manufacturer was struggling to solve serious problems with susceptibility in this series of mixers, especially to AM broadcast stations around 1.5 MHz. The mixer shown in Figure 23 is from the problematic group. The mixer shown in Figure 24, introduced about three years ago, significantly reduced the number of complaints on the basis of improved pin immunity in this frequency range.

[4] The mixers of Figures 25 and 26 were introduced about a year later.

Unfortunately, it appears that this manufacturer hasn't learned much about eliminating susceptibility to RF on the signal pair, and all four of these mixers performed very poorly in the field tests, especially with foil/drain cable. Immunity has gotten worse for RF on the signal pair below 2 MHz.

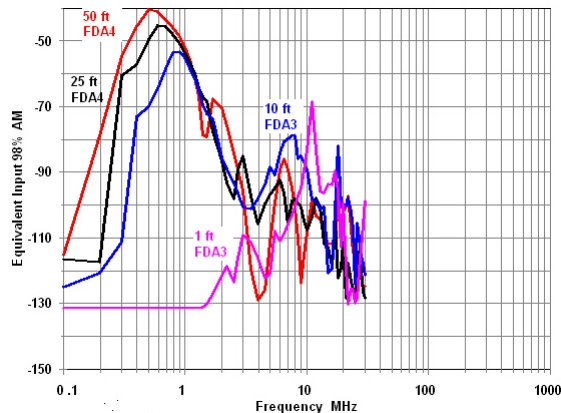

Figure 25 Susceptibility to SCIN coupled voltage on the signal pair for a newer 4-input mixer.

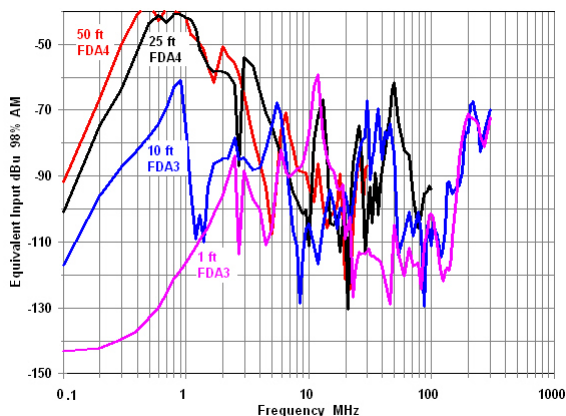

Figure 26 Susceptibility to SCIN coupled voltage on the signal pair for an 8-input mixer.

ANALYSIS AND DISCUSSION

Field test results are summarized in Tables 1 and 2. For these tests, the level of interference was evaluated by the author on a 12-step subjective scale, ranging from inaudible to extremely severe. Those steps were then converted to whole numbers, with 0 being no interference and 11 being extremely severe. The three highest steps corresponded to interference that was so severe that it shut down a gain stage to the extent that the mic could not be heard and caused circuit instability. All of the amateur radio transmit-

ters used Morse code (the radio signal is switched on and off in temporal patterns that correspond to alphanumeric characters), so the transmission was equivalent to 100% modulation of the signal with a relatively fast switching waveform. For the most part, interference is heard as clicks, but under some conditions, it will be accompanied by hum. Josephson has hypothesized that this hum may be the ripple in the phantom supply due to the input stage losing CMRR as a result of RF detection in the input devices. [3] Whitlock has observed that hum will be added to detected RF by modulation of the RF current when it travels through the power supply. [8] He has identified the cause is modulation of the impedance of that current path by the ac signal. At the highest levels, the interference is causing fundamental overload. It is most likely that the transition to instability occurs somewhere above where overload begins. [

As previously noted, the Sound Devices preamp responded with a high pitched squeal in the presence of the 3.5 MHz and 7 MHz transmitters. The high frequency oscillation observed with a few microphones at 1.8 MHz and 3.5 MHz sounds suspiciously like this squeal. It is possible that the interference noted at 1.8 MHz for microphones TL1-1-10 and TS3-1-10, and the interference noted at 3.5 MHz for TMO7 might be caused by the preamplifier and not the microphones. On the other hand, it is also possible that the microphones are at fault, and are simply responding similarly to the interference. Squealing was experienced with the other mixers in various test conditions, but those mixers were tested only with dynamic microphones so that susceptibility of an active microphone could not cloud the result.

An analysis of the field test results allows some important observations. The performance of the microphones with braid/drain shielded cable at frequencies up to 7 MHz is particularly noteworthy. None of the microphones received interference at 720 kHz or 1.8 MHz with braid/drain shielded cable, even though some did with foil/drain shielded cable. Only one microphone (DSA3) received interference stronger than "slight" (slightly audible clicks) with the braid/drain cable at 3.5 MHz. That microphone and one other received moderately strong interference (prominent, but well below clip) at 7 MHz; no other mics received interference at 7 MHz with the braid/drain shielded cable.

The 1.8 MHz field test results should be viewed as approximately indicative of performance in the upper portion of the AM broadcast band, and the combined 720 kHz and 1.8 MHz results roughly indicative of performance in the AM broadcast band as a whole.

DUT / FREQ	720kHz	1.8 MHz	3.5 MHz	7 MHz	14 MHz	28 MHz
TL1-1-10	0	3	1	0	0	0
TL1-2-10	0	0	3	0	0	0
DL1-1	0	0	0	0	0	0
DL1-2-10	0	4	4	0	0	0
DS1-2-10	0	6	5	0	0	0
DS1	0	8	0	0	0	0
TS3-1-10	0	6	1	0	9	5
DL3-1-15	4	4	7	0	8	0
DS3-2-25	4	4	6	0	7	0
TSA3	4	8	7	6	6	4
TL2-20	0	0	0	0	0	0
DS2-10	5	6	7	0	7	1
TS2-2-15	0	6	5	0	8	5
TMO5	0	0	0	0	4	0
TMO7	0	0	3	0	0	0
DL4-2-10	4	0	0	0	0	0
DS4	5	6	4	0	0	0
DL6-2	9	8	7	0	5	0
Ds9	0	0	0	0	0	0
MixPre	0	0	4	0	0	0
4-in Mix #1	11	9	9	6	9	4
16 in Mix	6	4	5	3	8	7
4-in Mix #2	11	10	11	11	7	6
8-in Mix	11	11	11	10	7	0
DAT-Full Gain	9	11	11	11	8	6
DAT -20 dB	6	5	11	7	10	0

Table 1 Summary of Field Tests Results with Foil/Drain Shielded Cables

DUT / FREQ	720kHz	1.8 MHz	3.5 MHz	7 MHz	14 MHz	28 MHz
TL1-1-10	0	0	0	0	0	0
TL1-2-10	0	0	0	0	0	0
DL1-1	0	0	1	0	0	0
DL1-2-10	0	0	0	0	0	0
DS1-2-10	0	0	1	0	0	0
DS1	0	0	2	0	0	0
TS3-1-10	0	0	0	0	7	6
DL3-1-15	0	0	1	0	0	0
DS3-2-25	0	0	1	0	0	0
TSA3	0	0	6	5	6	6
TL2-20	0	0	0	0	0	0
DS2-10	0	0	2	0	6	6
TS2-2-15	0	0	1	5	7	8
TMO5	0	0	0	0	5	4
TMO7	0	0	0	0	0	0
DL4-2-10	0	0	0	0	0	0
DS4	0	0	0	0	0	0
DL6-2	0	0	0	0	0	0
Ds9	0	0	0	0	0	0
MixPre	0	0	3	0	0	0
4-in Mix #1	6	7	7	0	9	6
16 in Mix	0	0	3	0	7	8
4-in Mix #2	4	4	3	7	7	6
8-in Mix	0	6	7	9	7	0
DAT-Full Gain	5	0	8	6	7	7
DAT -20 dB	3	0	2	5	4	3

Table 2 Summary of Field Tests Results with Braid/Drain Shielded Cables

CABLE TYPES

At 7 MHz and below, virtually all of the equipment tested received significantly less interference when braid/drain-shielded cable was used than with foil/drain shielded cable. At 14 and 28 MHz, there were significant differences between foil/drain and braid/drain cable, but the differences were less pronounced, and especially at 28 MHz, the foil/drain cable was more likely to have the advantage.

The two cables types used in the field tests were tested and identified as FDA3 and BDD1 in [2] (and were, in fact, the actual cable samples measured for the earlier paper). FDA3 has a foil/drain shield, while BDD1 has a braid shield with a drain wire. Table 3 summarizes the measured difference in the level of SCIN between the two cable types. In [2], the authors observed that the difference between the two cable types decreased with increasing frequency, and hypothesized that braid cable might lose its advantage over foil/drain cable at some higher frequency.

Freq (MHz)	Relative SCIN (dB)
.72	22 dB
1.8	17 dB
3.5	10 dB

Table 3 Relative SCIN of Foil/Drain Cable compared to Braid/Drain Cable; average of 125 ft, 50 ft, 25 ft, and 10 ft samples [2]

The results of both field testing and laboratory field testing are generally consistent with the SCIN data measured in [1] and [2] and with that hypothesis. Since the effect of cable construction was not the primary focus of the current work, and because time for experimental work was limited, only a few laboratory measurements were made using cable types other than the foil/drain-shielded cable. The lowest curve in Figure 24 is for 25 ft of the dual spiral shielded cable type SD tested both in [1] and [2]. A comparison with the 25 ft length of foil/drain cable FDA4 (the black or darkest curve) shows results that are consistent with [2], taking into account the fact that detected interference generally follows the square law above the threshold of detection and below fundamental overload.

Results of field testing strongly indicate that at frequencies below 30 MHz, inadequate low-pass filtering for RF on the signal pair appeared to be the primary cause of poor immunity. One comes to this conclusion by observing that for virtually every DUT and every frequency tested, if interference was received, the strength of the interference was strongly affected by the cable type that was used.

This result should not be taken to mean that pin 1 susceptibility is never a factor below 30 MHz, but rather that for a single device and a single input, it

appears to be secondary in importance to low pass filtering. And there can certainly be instances where a mixer tested here could receive pin 1-related interference when placed in a real world installation. That possibility is discussed in [4].

HOW MUCH IMMUNITY IS ENOUGH?

The tests reported here could be seen as rather severe, to the extent that they subjected the DUT to considerably more field strength than is likely to be encountered by the vast majority of users. The broadcast station on 720 kHz is one of a few hundred in North America licensed for this high power level, and most are surrounded by at least a few hundred meters of vacant land to accommodate their ground system. While it's not easy to get a lot closer to a transmitter of this power level, at least 50 residences are within an equivalent distance of this particular installation, and more would be if the transmitter were not adjacent to a large swampy area.

Likewise, the microphone cables were set up within 20 feet of amateur radio antennas radiating 100 watts. Amateurs are licensed for up to 1500 watts, only 12 dB greater than this level, but most choose to operate at 100-200 watt levels to avoid EMI problems. Also, it is unusual for an audio installation to be this close to an amateur transmitting antenna, which is usually (but not always) associated with a private residence. Simple circumstances of real estate are likely to force separations at least 6 dB greater. The American Radio Relay League, the national organization of amateur radio operators, recommends an immunity standard of 3V/m for consumer electronic devices, saying that this level of immunity should protect a device 100 ft (31 m) from a dipole antenna radiating 100 watts. [9] Federal Communications Commission (FCC) rules do not currently include such a standard.

By virtue of their proximity to the transmitting antennas, both the Field Day and 720 kHz test conditions were on the order of 10 V/m. Churches, broadcast facilities, and recording studios are often adjacent to transmitting antennas like those describe here. Corporate board rooms are often in the upper floors of high rise buildings where they have significant exposure to VHF and UHF broadcast transmitters. Virtually all equipment can be exposed to cell phones in very close proximity. A significant number of tested products rejected most of the interference to which they were subjected in these tests and those outlined in [1]. All of them could have rejected all of the interference with even the most basic attention to good engineering practice. In the author's judgment, they should do so.

ACOUSTIC CONDITIONS

The acoustic conditions for the laboratory and field tests were not ideal, and influenced the sensitivity of

the tests. The grassy field where the 720 kHz tests were performed is less than 200 m from a major freeway and a busy local road. Typical levels were measured at 53 dBA and RC47. A church could be expected to be more than 10 dB quieter; a recording studio at least 20 dB quieter. The Field Day site was much better, at 37 dBA and RC30 during quieter hours when most of the measurements were done.

The noise level in the author's laboratory was 47 dBA, RC 42. The background noise level in the 1 kHz one-third octave band was about 35.5 dBSPL. The limiting factor was the RF generator's fan (which needed to be close to the microphone so that its output cable could be very short to minimize the effects of standing waves). There are also computers and support equipment.

Most detection has a square law response. Thus a 20 dB increase in the acoustic noise floor could be viewed as equivalent to a 10 dB reduction in sensitivity to the level of the RF signal, which in turn is equivalent to being 3.16X more distant from the transmitter. In other words, taking the acoustic noise floor into account, the test conditions are equivalent to being in a recording studio 1.9 km from the 720 kHz transmitter, or in a church at a distance of about 1 km. Much less adjustment is needed for the acoustic conditions at the Field Day site, which was quieter than many churches but noisier than most recording studios.

COHERENT SUMMING

Coherent summing of interference received at multiple inputs can also cause relatively low levels of interference to be heard at significantly higher levels than these data suggests. When signals sum coherently, they will add by 6 dB for each doubling of the number of signals of equal strength. When they add non-coherently, they add by 3 dB per doubling. Program audio received by multiple microphones will be non-coherent. Thus the ratio of received interference to program audio can increase by as much as 3 dB for each doubling of the number of inputs receiving interference and detection mechanisms.

To understand how coherent summing affects RF interference, consider a mix console with 32 inputs connected to 32 long microphone lines, each carrying shield current from some interference source. In many situations, the current will divide between the various microphone cables (if, for example, they are bundled together and follow the same path), and the radio frequency voltages may be quite small on each input, perhaps small enough to remain below the threshold of detection. If it is above that threshold, detected interference (that is, the audio) will generally be in phase, and will sum coherently. In this situation, the interference is made no better or no

worse by the multiple inputs.

Now, consider the worst case where a radio transmitter is able to induce just as much voltage and current in each of 32 cables as it does in one cable. For example, all the cables may be exposed (not in grounded metallic conduit) and follow different routes to the mix console. In this extreme case, the detected interference would sum coherently (because it is the same on all the channels), while the audio program material, being different on the 32 inputs, would sum non-coherently. In a simplistic "worst-worst" case scenario where all inputs receive equal interference and are mixed at equal gain to the output buss, the signal to interference ratio would be degraded by 15 dB as compared to that of a single input.

Coherent addition can also result from the detection of the same signal at more than one stage in a signal chain. When this happens, the audio by the second stage will generally be in phase with the audio detected by the first stage, but may be either in or out of polarity with it. The summing of RF paths to a common detection point is probably responsible for most of the narrowband peaks and nulls in the curves at VHF and UHF.

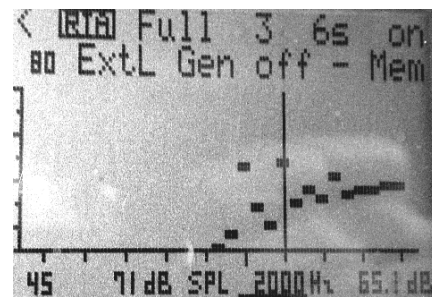

Figure 27 – Audio Tool Box Real Time Analyzer showing significant harmonic content

Although most detected audio is relatively undistorted, not all is. Figure 27 shows significant second, fourth, and fifth harmonic content, and there were many instances where the fundamental was at significantly lower amplitude than the harmonics. This can happen by several mechanisms. They include summing of a signal detected at more than one point within the DUT with some combination of phase shift or polarity reversal in the audio path that combines those points to the output so that the fundamental is at least partially cancelled, and significant distortion in one or more of the detection mechanisms. In instances like this, the interference level was considered to be the rms sum of the fundamental and the harmonics.

Some of these peaks and nulls can also be part of the test setup. Because the short coaxial cable running from the generator to the injection cable is driving a mismatched load, there will be strong standing waves

on that transmission line, establishing peaks and nulls at various frequencies that may be shifted slightly up or down in frequency by the interaction of that transmission line with its termination at the injection cable. This effect can be minimized by placing a resistive attenuator (pad) at the end of that line adjacent to the injection cable. The pad terminates the line, reducing any standing waves to a much lower value, but with the obvious effect of reducing the shield current. This option was not tried, since when the testing methods were established it was believed that it was necessary to have the greatest practical level of excitation to expose susceptibility.

In fact, the higher level of excitation may not be necessary, or may not be necessary at all frequencies. The data suggest that, especially at VHF and UHF, the test setup may be more sensitive to susceptibility than is required. Future refinements of the test method might include an attenuator designed for a matched attenuation on the order of 6 dB at frequencies where the load impedance is small and 10 dB where it is high. When the load impedance is low the attenuation in the test would be significantly greater than the matched attenuation because the load (the shield) approaches a short circuit, the peaks and nulls would be greatly reduced in magnitude.

SCIN AND EXISTING CABLES

The weight of research has shown that cables with poor SCIN performance at the frequency of potential interference sources can easily increase differential mode voltages by 30 dB or more. The author has shown [2] that cables having foil/braid shields can provide the higher level of performance, but to the best of his knowledge none are currently distributed in North America. And even if they were to appear tomorrow and be universally adopted, it would be many years before the vast majority of existing systems with foil/drain cable already installed would be replaced. Thus all equipment designs must include sufficient differential mode low pass filtering to provide immunity with these existing cables.

It is common for systems utilizing foil/drain shielded microphone cables to experience interference from AM broadcast transmitters. In the majority of cases, that interference can be eliminated or greatly reduced simply by replacing the cable with braid-shielded cable. Unfortunately, the author is not aware of any braid-shielded, balanced audio cables suitable for permanent installation. Braid-shielded audio cables currently available in North America are designed only for portable use. They do not meet fire safety standards, and are not designed to be pulled in conduit. In most jurisdictions, their installation would be a violation of electrical codes. It is critical that this situation be corrected.

WRETCHED EXCESS

European Standard EN 55103-2 [10] establishes a protocol for immunity of equipment that is essentially voluntary, in that multiple levels of immunity are described and tested for, and the product documentation simply states the level that is attained. A product used only in areas where interference is at a relatively low level may not need the same immunity performance as one installed next to a broadcast transmitter. In the author's opinion this is a good system.

Unfortunately, some EMC engineers and manufacturers of equipment have chosen to push for compliance by all products and systems with the most stringent immunity standards, and to establish EMC standards and practices for installations, connectorization, and wiring to support these levels of performance. These overly stringent standards would impose excessive engineering and manufacturing costs on all manufacturers, and some of the proposed wiring standards would seriously compromise the immunity of many portable and installed systems to audio frequency noise generated by power systems.

The author considers this approach myopic to the extreme. Like any engineering problem, EMC must be seen in the larger view. It should not be necessary to compromise immunity to audio frequency noise related to the power system to meet more stringent RF immunity standards than are justified by field conditions. A thoughtful analysis of the laboratory data and comparison with the field test results demonstrates that AES14 is entirely sufficient for providing immunity if the microphones and other equipment to which that wiring is connected conform to good engineering practice.

Total immunity to all of the lab tests described here is rarely necessary in the field. Many products that were immune to the very demanding conditions of the field tests exhibited measurable susceptibility in the lab at the same frequencies.

The products that performed poorly in the field tests were those where insufficient attention was given to 1) avoiding pin 1 problems; 2) preventing differential mode RF from reaching active circuitry; or 3) omitting important parts like bypass capacitors and ferrite beads on input, output, and power wiring. Another common error is the belief that common mode performance on a test bench is representative of the performance of the DUT with long runs of practical cables and line drivers. Among the reasons why this is not true are 1) the impedance imbalance of the circuit caused both by the imbalance of the generator impedance and the capacitive imbalance of the line; and 2) overloading of the input circuit by a signal that causes signal voltages in the circuit to exceed its power supply voltage. [6]

Two products tested are particularly noteworthy. The Sound Devices preamplifier received virtually no interference in any of the field tests other than the high frequency oscillation with two of the ham transmitters.

Microphone DS1 received interference in only one test condition -- the 1.8 MHz ham transmitter with foil/drain shielded cable. In the tests described by [1], it was the only microphone tested that experienced no interference in any of the tests with VHF/UHF transmitters beyond slight interference from a cell phone. Surprisingly, the connector in this microphone makes no contact whatsoever with the shell of a mating connector! This microphone was not tested in the lab because the test setup required contact with the microphone's shielded shell and there was insufficient time to construct a special adapter to provide that contact.

While the use of a well designed transformer at device inputs and outputs inherently provides low pass filtering, the presence or absence of a transformer did not correlate with immunity or lack of it. Some transformer-coupled microphones performed very well in these tests, but others performed quite poorly. Although the presence of a transformer did tend to correlate with very good immunity below about 10 MHz, some transformerless designs also had excellent immunity in this range. In the field tests for [3], microphone TL1-1-10 received considerable audio frequency interference from automotive wiring when it was laid on top of the windshield of the author's automobile. Inadequate magnetic shielding of the transformer, possibly combined with inadequate twisting of the signal wiring, is the suspected cause.

SPECTRUM USE ISSUES

The predominant RF interference sources at MF (300 kHz – 3 MHz) and HF (3 MHz – 30 MHz) are:

- ♦ AM broadcast transmitters (540-1700 kHz). These transmitters are licensed for output power levels between 1,000 W and 50 kW. Many transmitters are licensed for full power and non-directional antennas during daylight hours, but may be required to use lower power and a directional antenna at night. Virtually all antennas for these stations are surrounded by a radial ground system centered at the base of the tower. Radials are usually one-quarter wavelength long (about 140 m at 540 kHz, 45 m at 1700 kHz), but can be longer. [The function of this ground system is not safety, but rather to increase the radiation efficiency of the antenna system.] Many of these stations use multi-tower directional arrays, and each tower in the array will have such a ground

system. Thus the ground system provides at least a minimal buffer between the antenna and a potential victim audio system.

- ♦ Amateur radio transmitters (typically 300-500 kHz wide bands around 4 MHz, 7 MHz, 10 MHz, 14 MHz, 18 MHz, 21 MHz, 24 MHz, and 28 MHz). Licensed amateurs are permitted any transmitter output power up to 1,500 watts, but most use considerably less. Many use 100 watts with a half-wave dipole or quarter-wave vertical antenna. Those with the space to do so often use 3-element directional antennas. Antennas are typically installed between 10 and 20 m above ground. The separation between these interference sources and a victim audio system may be as little as 20-30 m.
- ♦ Citizens band transmitters (around 27 MHz). While these transmitters are licensed for a maximum of 5 W, illegal operation at 200 watts or more, is common, especially by taxi drivers in major cities.
- ♦ International shortwave broadcast transmitters (4.5 MHz – 24 MHz). These transmitters operate with output power on the order of 50-250 kW and generally utilize very directional antennas (20 dB or more gain in the desired direction relative to a dipole). Field strengths in the main lobe can thus be quite high, but the main lobe will correspondingly narrow.
- ♦ Unintentional radiators. Examples are the arcing of faulty components of power and lighting systems, and impulse noise routinely produced by lighting systems and motors. Lighting starters, ballasts, and dimmers are an especially common source of MF and HF noise. The strength of this interference is limited by regulations in most countries, but regulations are poorly enforced, particularly in the US. It is common for these noise sources to be quite close to audio systems (often in the same space) and for the interference to be carried on (and radiated by) mains power wiring.

SIMPLE SOLUTIONS IN THE FIELD

In the 720 kHz field tests, the connection of the chassis of the input equipment to ground (earth) provided a path for current flow on the shield, exciting both SCIN and any pin 1 problems that might be present in the equipment on either end. The interference was significantly reduced in level with most of the products tested (and in some cases eliminated) when the 25 ft section of braid/drain shielded mic cable with the 12 turn toroidal choke used in the lab tests (see

Figure 6) was added in series with the input of the device under test. This was not tried at the Field Day site, but would almost certainly have had an even greater effect at the higher frequencies in use there.

RF interference commonly enters audio equipment via its output wiring. The author has successfully eliminated moderately strong interference to consumer stereo equipment from his 100 watt ham transmitter operating on 3.5 MHz, 7 MHz, 10 MHz, 14 MHz, 21 MHz, and 28 MHz by the simple expedient of wrapping each of the loudspeaker cables three turns around a 1.4 inch OD, 0.9 inch ID toroidal ferrite core of #43 material. A separate core was used for each cable.

The same core is likely to be quite effective for a microphone input. The inductance of such a choke is proportional to the square of the number of turns. It is possible to improvise a 4-turn choke by passing a miniature mic cable (for example, one pair of a multi-pair cable) with a male XL connector attached without removing the connector. A greater number of turns could be wound by removing the XL connector and replacing it. The 12-turn choke with the full-size microphone cable was easily wound on the 2.4 inch core without removing the connector.

Audio cable is generally relatively lossy at HF, so interference coupled to one end of a long audio cable is often significantly weaker by the time it reaches electronics that can detect it. In general, what matters most is the RF current flowing in the audio cable closest to the victim electronics. This becomes increasingly true at VHF and UHF, because cable losses increase with increasing frequency. The handheld transmitters used for the tests of [3] were most able to cause interference to condenser microphones when their (insulated) transmitting antennas were touching the microphone's cable (also insulated), but rarely able to cause interference if they were still touching the cable but more distant from the microphone than about one wavelength at their operating frequency. Thus, if a choke or other means is used to prevent shield current, it should be located as close as practical to the victim electronics.

COST ISSUES

Troubleshooting and correcting susceptibility problems in the field is almost always quite costly. Most systems consist of multiple pieces of equipment that could be responsible for all or part of the susceptibility. Lengths of interconnecting cables, cable types, their orientation with respect to the source of the interference, the degree of shielding of cables and equipment provided by raceways, equipment racks, and building structure, and the frequency of the interfering signal all affect the susceptibility of a given installation or portable setup. Specialized test equip-

ment, as well as technical expertise beyond that of most field personnel is usually required to diagnose which mechanisms, equipment, and conditions of installation are most responsible for the failure in a given installation. Many installations are at significant distance from the installing contractor's base of operations, resulting in additional costs.

Total costs to remedy susceptibility failures (that is, field diagnostics, re-engineering, field labor, travel, test equipment, and parts cost) can far exceed the cost of the defective equipment, often by an order of magnitude! At least one manufacturer has reported that their technical support costs were greatly reduced simply by eliminating pin 1 problems from their products. Similar results should be expected from comparable reductions in susceptibility of problematic equipment. Given these realities, there is simply no excuse for omission of the very low cost parts needed to provide reasonable immunity.

RESPONSIBILITY FOR INTERFERENCE

A properly licensed radio transmitter is never at fault when it causes interference to audio systems. [A possible exception might be a fault condition, such as when an arcing component might couple impulse noise to the power system.] When its antenna radiates an electromagnetic field it is performing exactly as intended, and it cannot fulfill its intended function if it does not do so. Rather, it is always the audio system or equipment that is at fault. It is not intended to respond to electromagnetic fields, nor does it need to do so to perform its intended function. The audio system's wiring should not couple the fields to audio circuits and those circuits should not detect the RF signals. When audio equipment detects radio frequency signals it fails to meet its design objective. In fact, any audio equipment or system that detects RF signals is either inadequately designed, uses inadequate components, is improperly built, or is defective.

CONCLUSIONS

1. Microphones and equipment with poor immunity to RF on the signal pair benefit the most from the use of cables having low levels of Shield-Current-Induced Noise.
2. In a previous study [2], the author observed that the data suggested that the advantage of braid shielded cable might disappear above 4 MHz, but that shield current induced noise likely continues to increase linearly with frequency well above that range. The results of the current work are consistent with both of those hypotheses. Field tests showed the clear advantage of braid shielded cables below about 7 MHz. Above that frequency, the

tests showed the advantage shifting in the favor of foil/drain shielded cables.

3. In a previous study, [2] the author noted the advantage of foil/braid shielded (that is, with the braid replacing the drain wire) cable up to 4 MHz. While doing research for [3], the author noted the improved shielding of foil/drain cable at VHF and UHF. That fact, taken in combination with the results of the current work, suggests that well manufactured foil/braid shielded cable would have the clear advantage throughout the RF spectrum over foil/drain, braid, or braid/drain shielded cables. Obviously, foil constructions are not good choices for all uses (for example, portable cables).
4. Foil/drain construction of audio cable shields should be discontinued and replaced by foil/braid construction. This simple change would reduce susceptibility of audio systems by at least 30 dB below 2 MHz and at least 20 dB up to 7 MHz.
5. In the previously cited works, [2, 3] the authors concluded that common mode filtering of the signal pair was not sufficient to block interference, and that differential mode filtering was needed. The current work leads to the same conclusion.
6. A successful strategy for RF immunity must include a combination of shielding, common mode rejection, differential mode low pass filtering, and proper termination of the cable shield.
7. An immunity of 10 V/m should be a design objective for all components of audio systems, and, at a minimum, all products should achieve 3V/m. Greater immunity may be required at frequencies used by cell phones.
8. The cost of correcting susceptibility failures in the field far exceeds the cost of including within equipment the bandwidth-limiting components that prevent the failures.
9. Poor susceptibility is often the result of RF coupled onto the output wiring of audio equipment.

ACKNOWLEDGEMENTS

Thanks are due to Ron Steinberg for extensive support with field testing and the loan of equipment; to Bill Stribling, Rick Renner, Hugh Daly, and Ken Reichel for loan of equipment for testing, to Bill Whitlock for his thoughts about the conceptual basis of the work, and to Whitlock, David Josephson, John Woodgate, and Bruce Olson for their reviews of the

draft.

REFERENCES

1. N. Muncy, "Noise Susceptibility in Analog and Digital Signal Processing Systems," *J. Audio Eng. Soc.*, vol 43, No. 6, pp 435-453, 1995, June
2. J. Brown, and B Whitlock, *Common-Mode to Differential-Mode Conversion in Shielded Twisted-Pair Cables (Shield Current Induced Noise)*, AES Preprint 5747, Amsterdam, March 2003.
3. J. Brown, and D. Josephson, *Radio Frequency Susceptibility of Capacitor Microphones*, AES Preprint 5720, Amsterdam, March 2003.
4. J. Brown, *Testing for Radio-Frequency Common Impedance Coupling (the "Pin 1 Problem") in Microphones and Other Audio Equipment*, Presented at the 115th Convention of the Audio Engineering Society, October 2003, NY
5. H. Ott, *Noise Reduction Techniques in Electronic Systems*, Second Edition, Wiley, New York, 1988.
6. B. Whitlock, "Balanced Lines in Audio Systems: Fact, Fiction, and Transformers," *J. Audio Eng. Soc.*, vol 43, No. 6, pp 454-464, 1995, June
7. A. Tsaliovich, *Cable Shielding For Electromagnetic Compatibility*, Chapman and Hall, New York, 1995
8. B. Whitlock, Personal communication with author, July 2003
9. American Radio Relay League, *Comments of ARRL, The National Association for Amateur Radio, before the Federal Communications Commission*, ET Docket No. 03-65, MM Docket No. 00-39, 21 July 2003
10. European Standard EN55103-2, European Committee for Electrotechnical Standardization (Cenelec), *Electromagnetic compatibility - Product family standard for audio, video, audio-visual and entertainment lighting control apparatus for professional use Part 2: Immunity*, Brussels, 1996